

Features

Truck	Standard	Options
48V permanent magnet synchronous drive motor	●	
Hydraulic power unit	●	
PU drive wheel	●	
1150mm fork length	●	
540mm outside fork width	●	
48V/80Ah lithium battery(EVE)	●	
Balance wheels	●	
Double load wheels	●	
Different length of forks		○
Different width of outside fork		○
Single load wheel		○
48V/105Ah lithium battery (EVE)		○
48V/125Ah lithium battery (CATL)		○
Cab		
Multi-function tiller	●	
Horn	●	
USB	●	
Key switch		○
Controls and instruments		
Electric steering(stand-on type)	●	
Systech controller	●	
Interactive meter	●	
Electronic lifting limitation	●	
PIN code access	●	
Safety		
Emergency disconnect switch	●	
Turning deceleration(stand-on type)	●	
Other		
48V30A charger		○
48V50A charger		○



HANGCHA GROUP CO., LTD.

Factory site: 666 Xiangfu Road,
Hangzhou, Zhejiang, China (311305)

Tel: +86-571-88926735 88926755
Fax: +86-571-88926789 88132890

sales@hcforklift.com www.hcforklift.com

HANGCHA GROUP CO., LTD. reserves the right to make any changes without notice concerning colors, equipment, or specifications detailed in this brochure, or to discontinue individual models. The colors of trucks, delivered may differ slightly from those in brochures.



Follow us on
Facebook



Follow us on
YouTube



Follow us on
WeChat



Available on the
App Store



Download "Hangcha
Forklift" App



ISO45001:2018



ISO14001:2015



ISO9001:2015



HANGCHA trucks conform
to the European Safety
Requirements.



X SERIES

HI-RANGE PALLET TRUCK
WITH LITHIUM POWER

With capacity of 2,000 to 3,000kg

LET THEM POWER UP



INNOVATIVE SOLUTIONS NEW POWER NOW

Innovative, reliable lithium-ion technology (Lithium Iron-Phosphate), which are developed jointly by HANGCHA and EVE. Battery cells and modules are from EVE, with reliable quality, exclusively for HANGCHA.

- / We use square lithium iron phosphate batteries and modules used in large quantities by commercial vehicles in mature economies.
- / Safe and effective: Charging efficiency as high as 95%.
- / Quick charging.
- / Long-working: 2000 charging cycles, capacity retention greater than 80%.
- / Maintenance-free: Battery does not require manual maintenance.
- / Green and clean: Pollution-free, zero emissions.

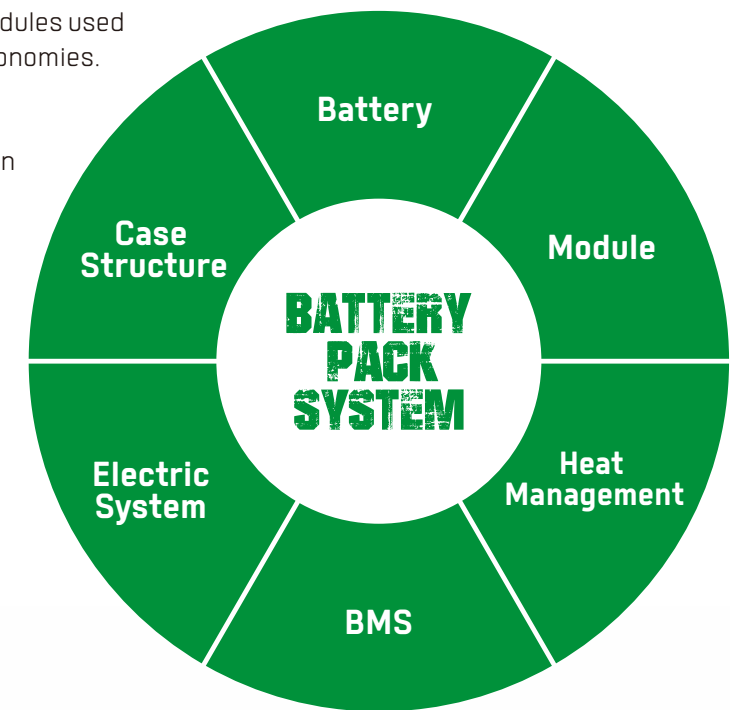

Rapid charging and opportunity charging ensure continuous availability of vehicles

Allow for fast full charging or boost charging. They are maintenance free and do not require a battery change when used for multi-shift operations.



HANGCHA provides Li-ion battery (LiFePO4) with 6 years or 12000 hours warranty.

**6 YEARS
WARRANTY**

POWERFUL DESIGN TO INCREASE PRODUCTIVITY

RELIABLE OPERATIONS ■

MAINTENANCE COSTS ■

RELIABILITY ■

■ NEW 48V SYSTEM

■ PERFORMANCE

■ COMFORTABLE

■ SAFE



X SERIES HI-RANGE ELECTRIC PALLET TRUCK

Your reliable, powerful and connected working machine.

X series Hi-range electric pallet truck are a new generation of products newly developed by Hangcha for warehousing and logistics applications. Using the advanced permanent magnet brushless drive technology and equipped with a new 48V system, the products have advanced performance, comfortable, safe and reliable operations and low use and maintenance costs, and are ideal tools for loading, unloading and handling palletized goods in warehouses, supermarkets, workshops and homes.

RUGGED ON THE OUTSIDE.

Made of high-strength steel plates that are molded by stamping, the vehicle exterior is robust, durable and high-grade, and meets environmental protection requirements.

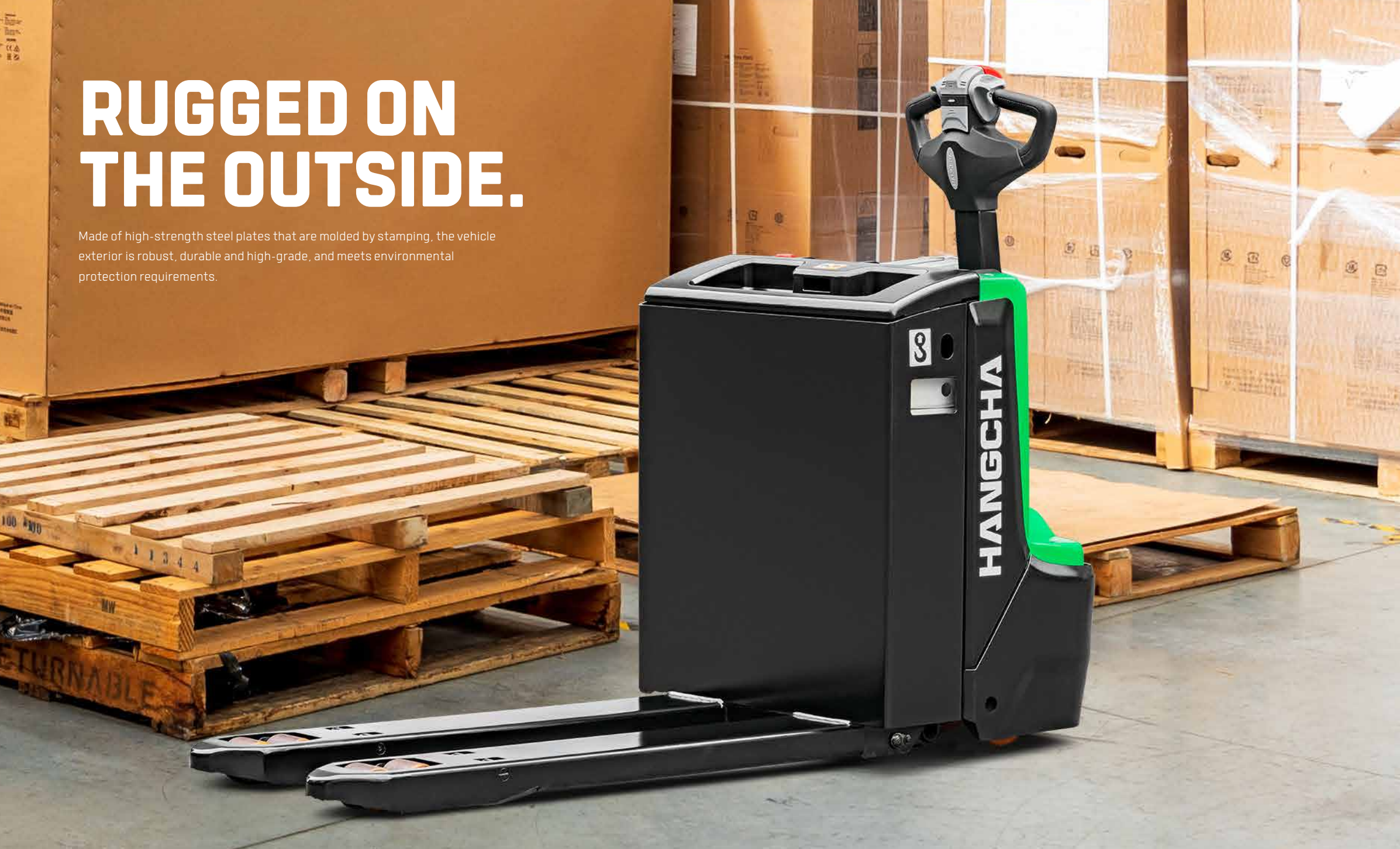

APPEARANCE

The X series Hi range electric pallet truck adopts a professional industrial design of exterior and a series family design. The vehicle has a smooth vivid profile and a fully ergonomic design, following the latest exterior design trend.



HIGH PERFORMANCE

- With high power drive motor, provides fast travel speed and good gradeability.
- The permanent magnet synchronous drive system has excellent performance and low energy consumption. The 48V power supply system has less heat generated.
- With the VCU control, the vehicle can be controlled accurately, stably and more efficiently.



Charging port

Pedestrian type

 **6.0** Km/h
Travel speed (laden)

 **10%**
Gradeability (laden)(2t)

Stand-on type

 **9.5** Km/h
Travel speed (laden)(2t)

 **10%**
Gradeability (laden)(2t)

The electronic steering provided for the standard configuration enables easier and more flexible operation.

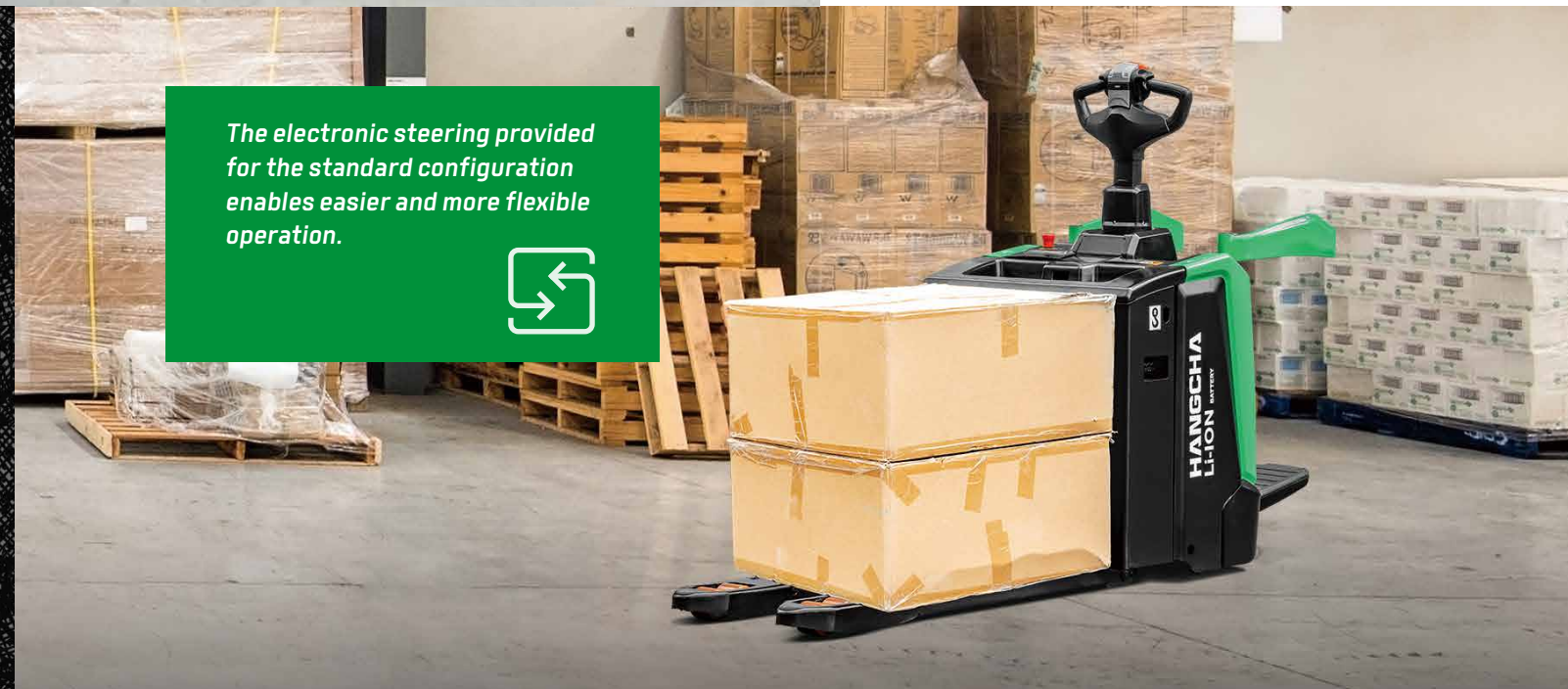

ENJOY YOUR WORK.

Customer can choose different width of outside fork and length of forks to fit variable pallet

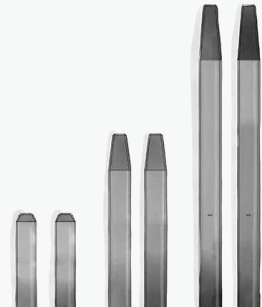

The new torsion bar - equipped auxiliary wheel system enables the vehicle to drive stably.



The standing driving pedal with shock-absorbing design significantly improves standing driving comfort and reduces long-time driving fatigue.

RELIABILITY

- With the low center of gravity design and a high-strength steel frame structure, the vehicle frame has a large residual load capacity.
- The hydraulic power unit applied to provide low noise, low vibration, smooth lifting and landing reliable operation.



MORE PROTECT



Water-proof plugs and connectors applied to provide a reliable protection to electric system.



The integral metal rear hood can withstand external impact.



The stamped fork with higher strength and impact resistance, and guided fork prongs, further improve operation efficiency.

NEW TILLER

- The novelly developed tiller is compact and stylish.
- Displayed turtle speed function applied to move slowly and helps to stack goods in narrow spaces.



PIN code access

COMFORT

- Optimized designing structure to offer a good visibility and easy entrance of the pallet.
- Using non-contact proximity switch, it can provides long life and reliable operation.
- The compact body and big rounded design provide an ideal operation in limited space, and the wedge designed chassis greatly increases the passing ability.



- Optimized rod which is stable, reliable and subject to a small force

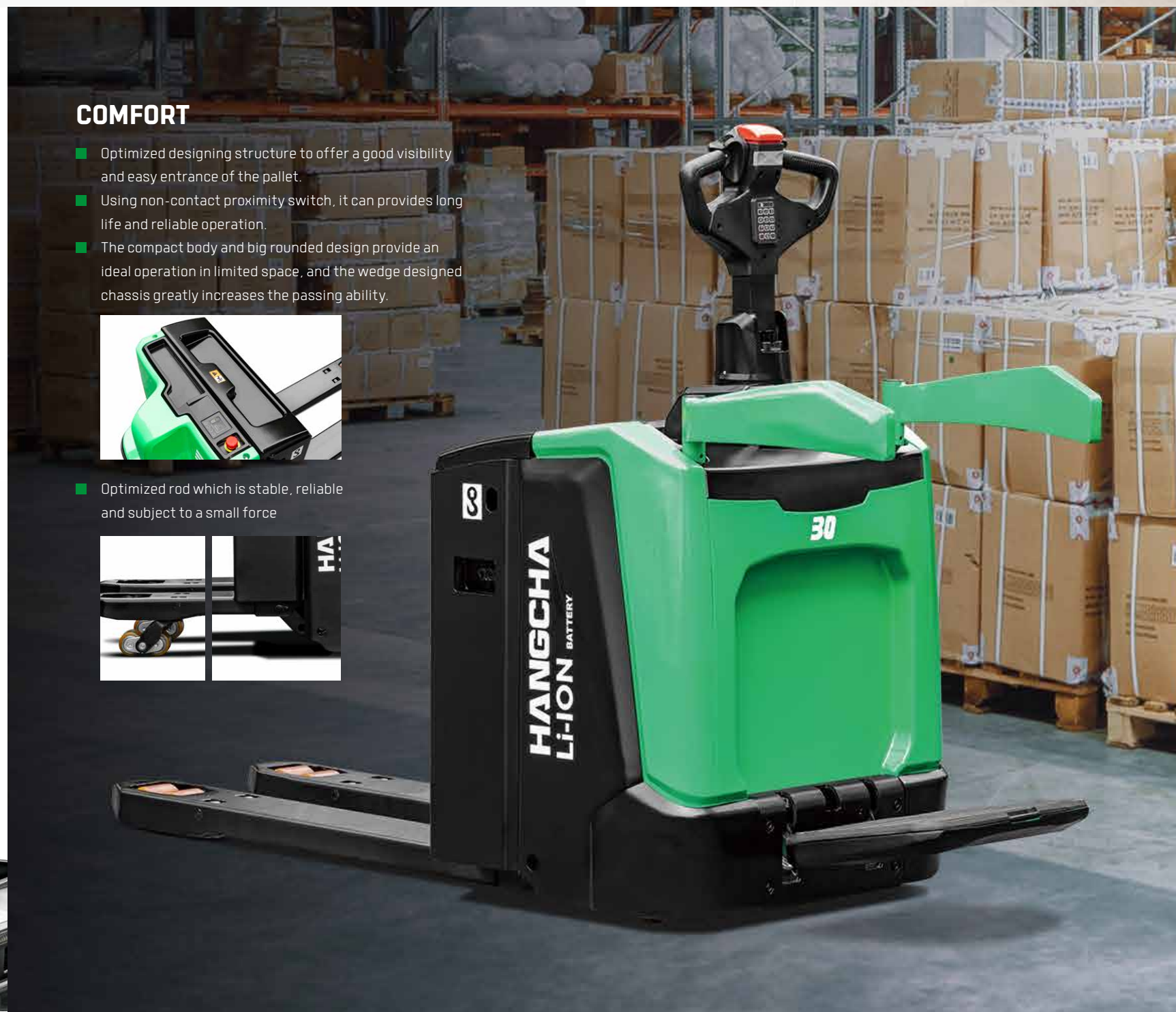

Pedestrian type use the new design drive system, the drive motor will not accompany the tiller rotation, it can keep all the cable connect to the drive motor avoid being bent.





The applied slope anti-slip function ensures the safety of the operation.

PROTECT YOUR INVESTMENT

WITH THREE BRAKING TYPES:

Releasing brake, reversing brake and emergency brake, the driving safety has been ensured.



The emergency button on the tiller head can effectively avoid the harm to the driver.

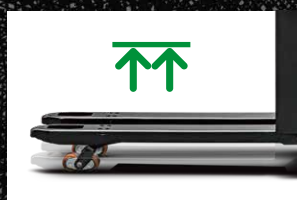

Lifting limitation switch to offer protection to the loads from damaging.



48V
VOLTAGE
WITH
PERMANENT MAGNET
SYNCHRONOUS DRIVE MOTOR

Maintenance-free permanent magnet synchronous motor.

MAINTENANCE

- All shafts installed lubricated shaft sleeve and oil cup, provide convenient maintenance and long service life.
- Rear cover can be completely open, operator can see all the components, so the maintenance is very convenient.

The fault information can be checked directly via the interactive instruments instead of the manual.



Technical data

Distinguishing mark	1.1 Manufacturer		HANGCHA GROUP CO.,LTD.	
	1.2 Manufacturer's type designation		CB020-XT1S-SI	CB030-XT1S-SI
1.5	Rated capacity	Q (kg)	2000	3000
1.6	Load centre distance	c (mm)	600	600
1.8	Load distance, centre of drive axle to fork	x (mm)	912/980	912/980
1.9	Wheelbase	y (mm)	1364/1432	1364/1432
Weight	2.1.1 Service weight		(kg)	610
	2.1.1 Service weight		(kg)	610
Tyres, chassis	3.1	Tyres: solid rubber, superelastic, pneumatic, polyurethane	PU	PU
	3.2	Tyre size, front	(mm)	Ø250-80
	3.3	Tyre size, rear	(mm)	Ø83-80
	3.4	Additional wheels [dimensions]	(mm)	Ø125-50
	3.5	Wheels, number front/rear [- = driven wheels]	(mm)	1x-2/4
	3.6	Tread, front	b10 (mm)	505
	3.7	Tread, rear	b11 (mm)	370
Dimensions	4.4	Lift	h3 (mm)	125
	4.15	Height, lowered	h13 (mm)	85
	4.19	Overall length	l1 (mm)	1854
	4.20	Length to face of forks	l2 (mm)	704
	4.21	Overall width	b1/b2 (mm)	770
	4.22	Fork dimensions DIN ISO 2331	s/e/l (mm)	60/170/1150
	4.25	Fork spread	bs (mm)	540/680
	4.32	Ground clearance, centre of wheelbase	m2 (mm)	23
	4.34.1	Aisle width for pallets 1000 × 1200 crossways	Ast (mm)	2064[2502] ¹⁾
	4.34.2	Aisle width for pallets 800 × 1200 lengthways	Ast (mm)	2114[2552] ²⁾
Performance data	5.1	Travel speed, laden/unladen	(km/h)	9.5/12.5
	5.2	Lift speed, laden/unladen	(m/s)	0.05/0.07
	5.3	Lowering speed, lade/unladen	(m/s)	0.06/0.06
	5.8	Max. gradeability, laden/unladen	(%)	10/16
Electric engine	6.1	Drive motor rating S2 60 min	(kW)	2.2
	6.2	Lift motor rating at S3	(kW)	2.2
	6.4	Battery voltage/nominal capacity	(V)/(Ah)	48/80
	6.4.1	Optional battery voltage/nominal capacity	(V)/(Ah)	48/105 48/125
	8.1	Type of drive unit		Permanent magnet synchronous

Note: 1) According to VDI2198 standard-430mm. 2)According to VDI2198 standard-236mm.

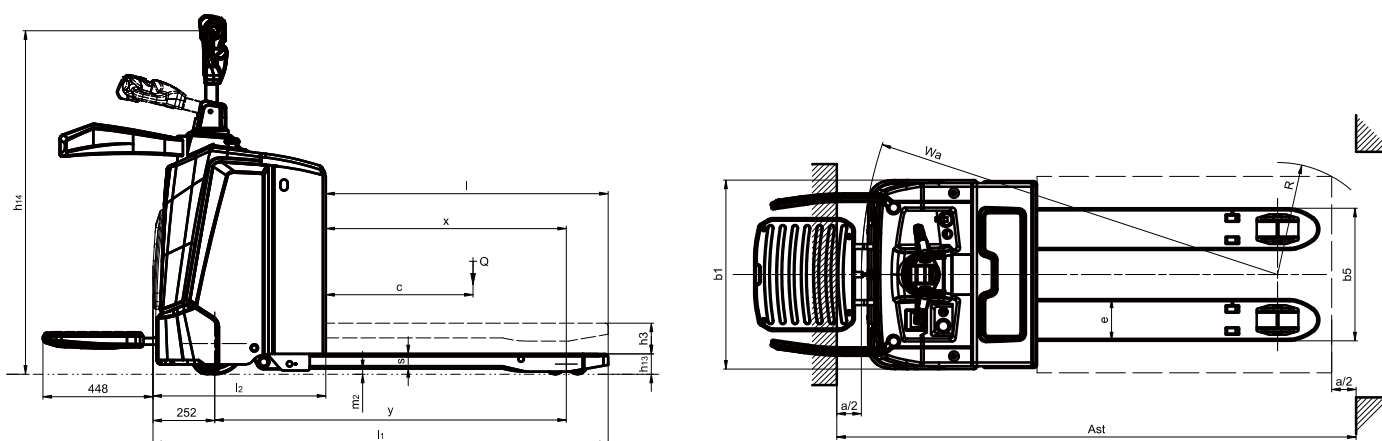

Technical data

Distinguishing mark	1.1 Manufacturer		HANGCHA GROUP CO.,LTD.	
	1.2 Manufacturer's type designation		CB020-XT1-SI	CB030-XT1-SI
1.5	Rated capacity	Q (t)	2000	3000
1.6	Load centre distance	c (mm)	600	600
1.8	Load distance, centre of drive axle to fork	x (mm)	912/980	912/980
1.9	Wheelbase	y (mm)	1340/1406	1340/1406
Weight	2.1.1 Service weight		(kg)	450
	2.1.1 Service weight		(kg)	450
Tyres, chassis	3.1	Tyres: solid rubber, superelastic, pneumatic, polyurethane	PU	PU
	3.2	Tyre size, front	(mm)	Ø250-80
	3.3	Tyre size, rear	(mm)	Ø83-80
	3.4	Additional wheels [dimensions]	(mm)	Ø125-50
	3.5	Wheels, number front/rear [- = driven wheels]	(mm)	1x-2/4
	3.6	Tread, front	b10 (mm)	475
	3.7	Tread, rear	b11 (mm)	370
Dimensions	4.4	Lift	h3 (mm)	125
	4.15	Height, lowered	h13 (mm)	85
	4.19	Overall length	l1 (mm)	1745
	4.20	Length to face of forks	l2 (mm)	595
	4.21	Overall width	b1/b2 (mm)	735
	4.22	Fork dimensions DIN ISO 2331	s/e/l (mm)	60/170/1150
	4.25	Fork spread	bs (mm)	540/680
	4.32	Ground clearance, centre of wheelbase	m2 (mm)	23
	4.34.1	Aisle width for pallets 1000 × 1200 crossways	Ast (mm)	2064[2502] ¹⁾
	4.34.2	Aisle width for pallets 800 × 1200 lengthways	Ast (mm)	1986[2356] ²⁾
Performance data	5.1	Travel speed, laden/unladen	(km/h)	6/6
	5.2	Lift speed, laden/unladen	(m/s)	0.05/0.07
	5.3	Lowering speed, lade/unladen	(m/s)	0.06/0.06
	5.8	Max. gradeability, laden/unladen	(%)	10/20
Electric engine	6.1	Drive motor rating S2 60 min	(kW)	2.2
	6.2	Lift motor rating at S3 15 %	(kW)	2.2
	6.4	Battery voltage/nominal capacity	(V)/(Ah)	48/80
	6.4.1	Optional battery voltage/nominal capacity	(V)/(Ah)	48/105 48/125
	8.1	Type of drive unit		Permanent magnet synchronous

Note: 1) According to VDI2198 standard-370mm. 2)According to VDI2198 standard-206mm.

